

GARAGE BEAM FORM SYSTEMS

SYSTEM COMPONENTS

- Beams, Split or Solid Style
- End Beams
- Frames
- Top Jacks
- Bottom Jacks
- Jack Retainers
- Stringer Support Arms
- Stripping Saddle Brackets
- Saddle Beams
- Stringers
- Crossbraces
- Push/pull Aligner Braces
- High Strength Fasteners
- Moving Dollies
- Stripping Trusses

BEAM FORM:

- Solid or Split
- End Beams
- Side Entry Beams
- Standard & Custom Lengths

JACKS:

- 18kip Capacity @ FOS=2.5:1
- Standard or Anti-topple Top Jacks

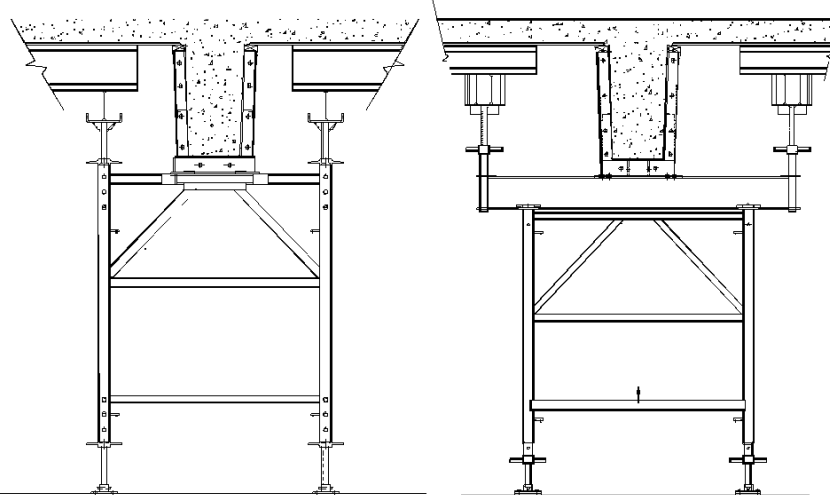

CONVENTIONAL LAYOUT

SADDLE-BEAM

FRAMES:

- 18kip Leg Capacity @ FOS=2.5:1
- 4' & 5' Wide Options
- Center Load Frames
- Adjustable Header Frames

WADCO INDUSTRIES, INC GARAGE BEAM FORM SYSTEMS

Consider the advantages of owning over renting:-

- no rental damage charges
- no lost part charges, (often at full list price)
- no hard-to-understand billings
- no time-related costs for project overruns & delays
- no rusted and/or poorly maintained parts

**OWNED EQUIPMENT
BUILDS
COMPANY EQUITY**

**FOR PRICING &
AVAILABILITY CALL TOLL-FREE**

(877)874-7888

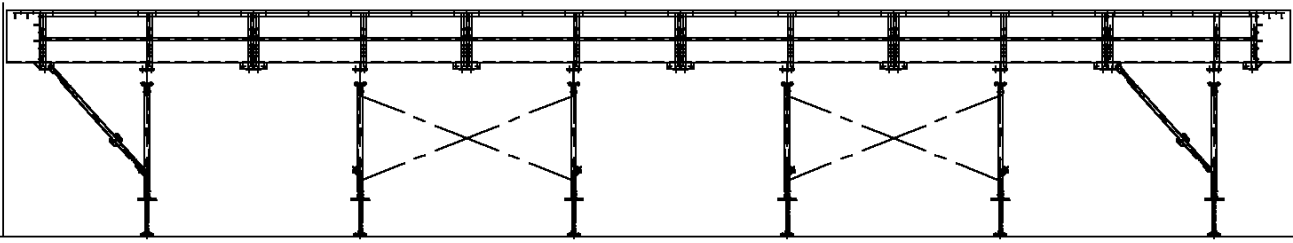

(A) WORKING CONFIGURATION
SCALE: 3/4"

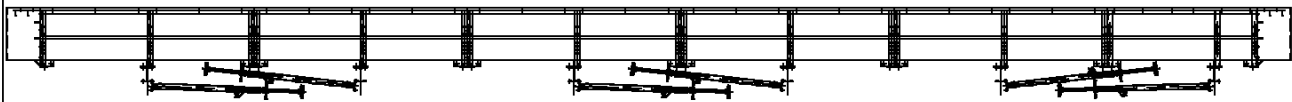

(B) STRIP CONFIGURATION
SCALE: 3/4"



INDUSTRIES, INC.

2625 SOUTH WILLOW AVE.
BLOOMINGTON, CA. 92316
TEL: (909)874-7800
FAX: (909)874-8046

CUSTOMER:

TITLE: BEAM FORM SYSTEM
GENERAL ASS'Y- ELEVATION

DRAWN:

DATE:

CHECKED:

REV DATE:

REV No:

JOB No:

DRG No:

BF1149

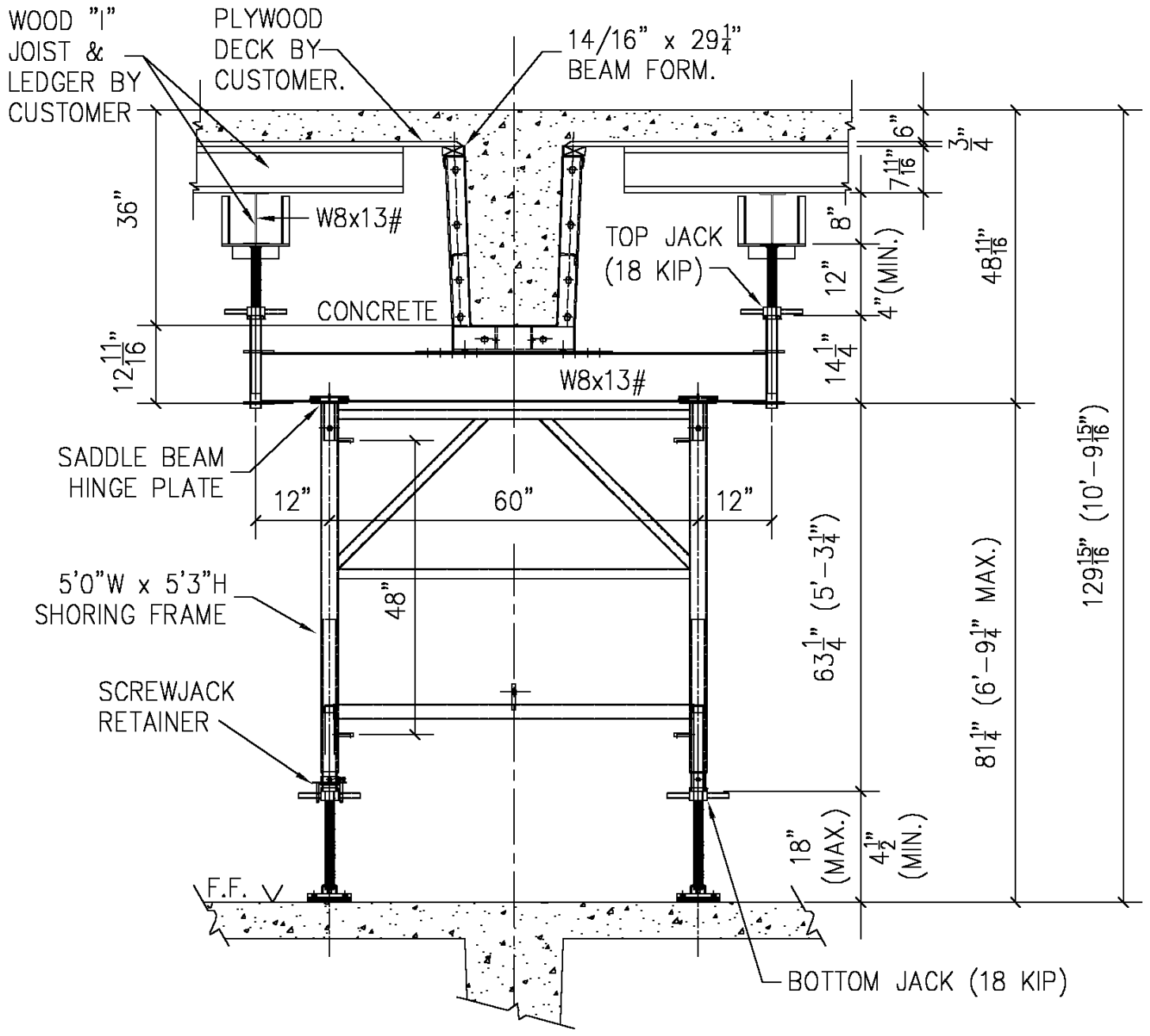

2625 SOUTH WILLOW AVE.
 BLOOMINGTON, CA. 92316
 TEL: (909)874-7800
 FAX: (909)874-8046

CUSTOMER:		REV DATE:
TITLE: BEAM SYSTEM SECTION GENERAL ARRANGEMENT		REV No:
DRAWN: LDR		JOB No:
DATE: 3/15/00		DRG No:
CHECKED:		WS-261

GENERAL CONSTRUCTION FORM SYSTEMS

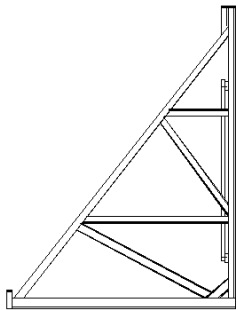

1-SIDED BRACE FRAMES

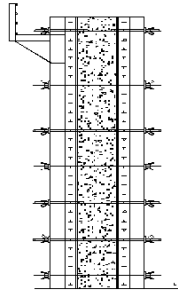

WALL FORMS

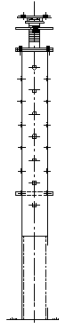

100K POST SHORES

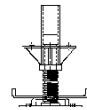

35K RESHORE

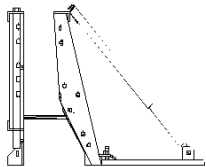

BARRIER RAILS

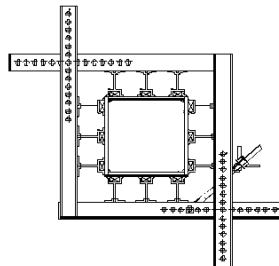

HD COLUMN SYSTEMS

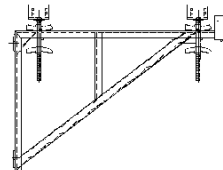

BRIDGE O/HANG JACKS

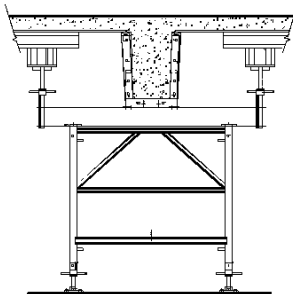

GARAGE BEAM

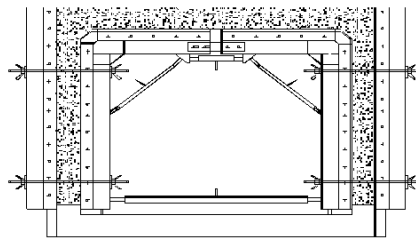

BOX CULVERT SYSTEMS

WADCO INDUSTRIES, INC FABRICATED FORM SYSTEMS

Wadco's competitive pricing allows ownership to become a practical possibility. Consider some of the advantages of owning over renting:-

- no third party control of inventory
- no rental damage charges
- no replacement charges for lost parts
- no hard-to-understand billings
- no time-related costs for project overruns & delays
- no rusted and/or poorly maintained parts

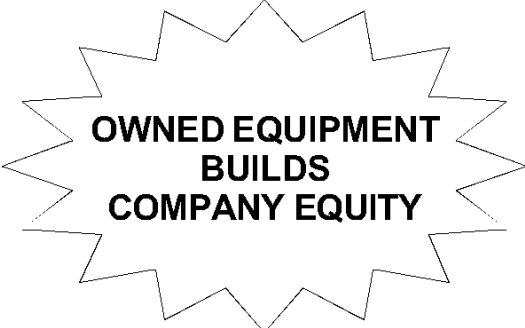

**FOR PRICING &
AVAILABILITY CALL TOLL-FREE
(877)874-7888**